

F 015 637 5A1

Stand }
Issue } 02-10-01

Abb./Fig. 1

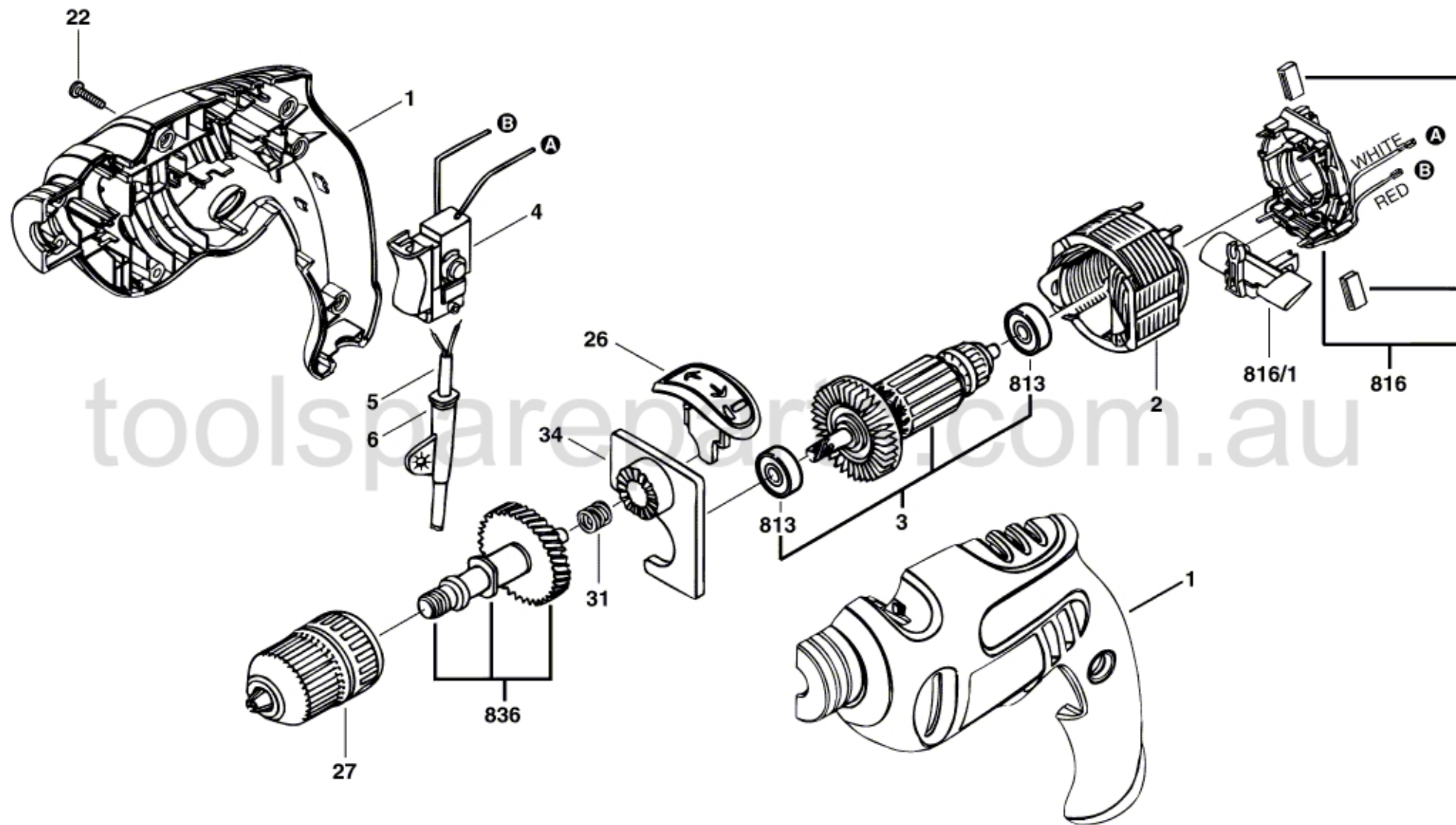

Änderungen vorbehalten
Modifications reserved
Modifications reserves
Salvo modificaciones